

MDR-903-700-26-OF

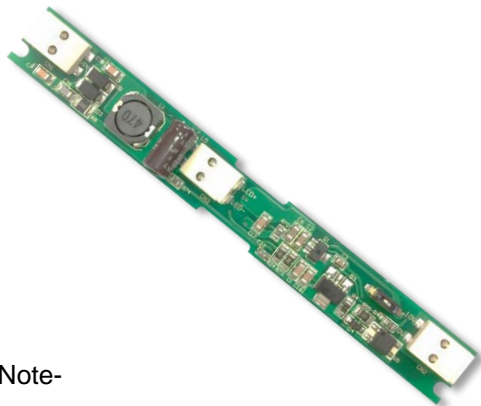

Compatible Track Adapter	Stucchi 9519-166-XX Stucchi 9529-166-XX
Compatible track system	Stucchi 9500 Multisystem
LED Driver Specification	20-37 VDC, 500-700 mA (DIP Switch) (See the page2)
Dimming	0-10V dimming, 5-100%

Note-

1. UL file: E340871

■ Mechanical

*Dimension
in metrics/inch

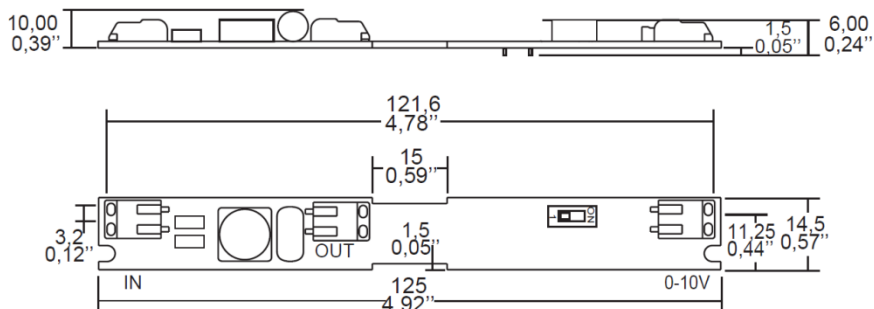

■ Electrical

Maximum load	26 W
Minimum load	10 W
Input Voltage	48VDC
Output Voltage	20-37VDC
Output Current	500 / 700 mA
Efficiency	>80%
No Load loss	< 1 W
Max. Tc Temperature	80°C

■ Wiring Diagram

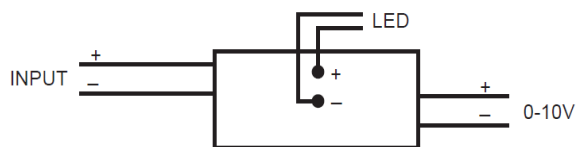

■ Efficiency of the driver VS Power Output (W)

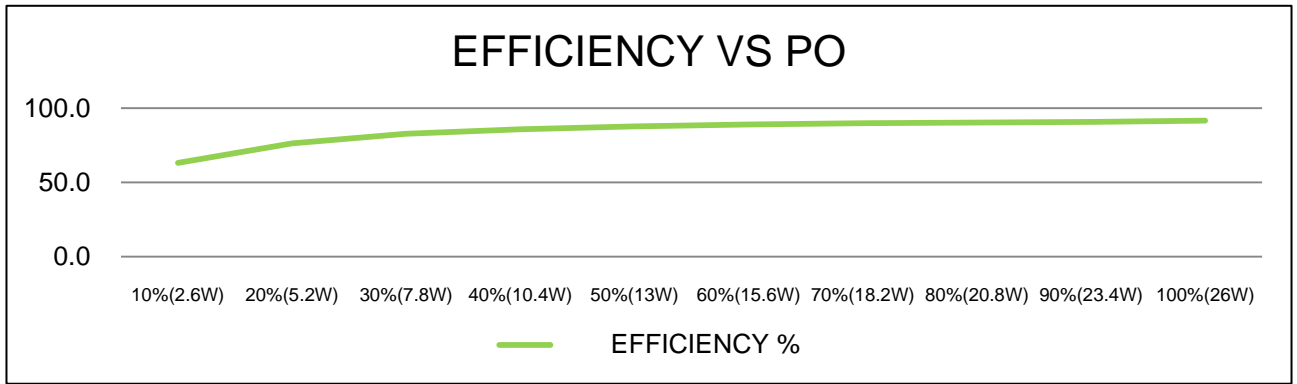

■ 0-10 V Dimming

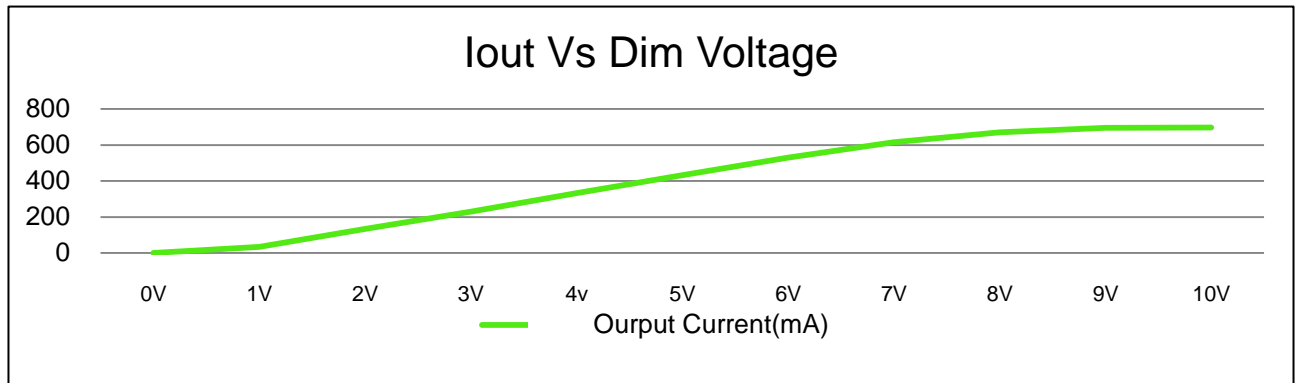

■ Current Setting

LED Current Tolerance over temperature and component variations is $500\text{mA} \pm 6\%$ / $700\text{mA} \pm 4\%$ at any level.

The output current of the driver can be adjusted using the two dip switches provided on the top of the driver. The below pictures shows the switch positions required to set the current to different levels.

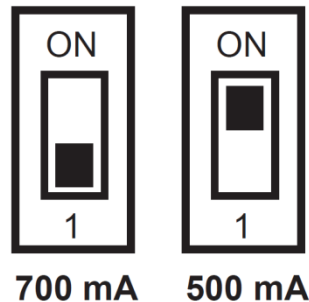

The driver will be shipped out of factory with both switches set to ON (700mA).



Macron Associate Co. – Power Supply Team

NO.352, Perng-Yi Road, Taiping, Taichung, Taiwan 411

TEL: 886-4-22708357 FAX: 886-4-22767307 Email: macron@macrongroup.com